

## KRO

KRATKA WENTYLACYJNA - OKRĄGŁA

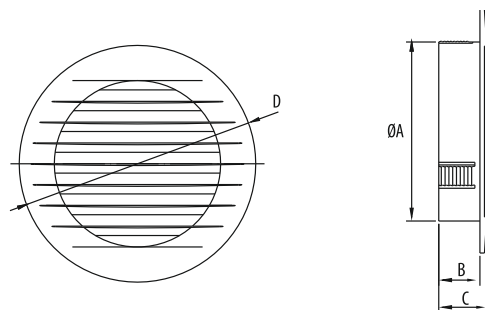

KRO Ø50 i Ø75



	A	B	C	D
KRO Ø50	50	8	10,5	62
KRO Ø75	75	10	13,5	87
KRO Ø100	99	23	26	133
KRO Ø125	124	27	31	160
KRO Ø150	149	34	38	184

<sup>1</sup>W przypadku wszystkich rodzajów kratki, przy zamówieniu powyżej 500 sztuk, istnieje możliwość doboru koloru (biały, brąz lub grafit).

TYP	INDEKS	KOLOR <sup>1</sup>	OPAKOWANIE ZBIORCZE	WAGA	CENA
jednostka			[szt.]	[kg]	[PLN]
KRO Ø50 (4 szt.)	007-4366	biały	20	0,038	8,35
KRO Ø50 (4 szt.)	007-4370	brązowy	20	0,038	9,18
KRO Ø50 (4 szt.)	007-4371	grafitowy	20	0,038	9,18
KRO Ø75 (2 szt.)	007-4365	biały	20	0,022	8,79
KRO Ø75 (2 szt.)	007-4372	brązowy	20	0,022	9,67
KRO Ø75 (2 szt.)	007-4373	grafitowy	20	0,022	9,67
KRO Ø100	007-0184	biały	20	0,042	2,88
KRO Ø100 /B	007-0312	brązowy	20	0,04	3,19
KRO Ø100 /W	007-4242	faktura drewna	20	0,028	10,01
KRO Ø125	007-0185	biały	20	0,062	3,21
KRO Ø125 /W	007-4243	faktura drewna	20	0,05	11,12
KRO Ø125 /B	007-0320	brązowy	20	0,058	3,53
KRO Ø150	007-0186	biały	20	0,1	6,16
KRO Ø150 /B	007-0310	brązowy	20	0,092	6,76
KRO Ø150 /W	007-4244	faktura drewna	20	0,084	13,35
KRO Ø100 /G	007-4309	grafitowy	20	0,04	3,19
KRO 100 /SM	007-0573	srebrny mat	20	0,04	8,19
KRO 100 /SP	007-0187	srebrny połysk	20	0,04	8,19
KRO 100 /ZM	007-0576	złoty mat	20	0,04	8,19
KRO 100 /ZP	007-0190	złoty połysk	20	0,04	8,19
KRO 125 /SM	007-0574	srebrny mat	20	0,062	10,62
KRO 125 /SP	007-0188	srebrny połysk	20	0,062	9,73
KRO 125 /ZM	007-0577	złoty mat	20	0,062	10,62
KRO 125 /ZP	007-0191	złoty połysk	20	0,062	9,73
KRO 150 /SM	007-0575	srebrny mat	20	0,15	13,04
KRO 150 /SP	007-0189	srebrny połysk	20	0,098	11,96
KRO 150 /ZM	007-0578	złoty mat	20	0,15	13,04
KRO 150 /ZP	007-0192	złoty połysk	20	0,098	11,96

TYP	INDEKS	KOLOR <sup>1</sup>	OPAKOWANIE ZBIORCZE	WAGA	CENA
jednostka			[szt.]	[kg]	[PLN]
KR Ø100/125	007-0153	biały	20	0,126	8,33
KR Ø100/125 B	007-0318	brązowy	20	0,126	9,20
KR Ø100/125 SM	007-0569	srebrny mat	20	0,126	21,52
KR Ø100/125 ZM	007-0571	złoty mat	20	0,126	21,52
KR Ø100/125 SP	007-0154	srebrny połysk	20	0,126	21,27
KR Ø100/125 ZP	007-0155	złoty połysk	20	0,126	20,35
KR Ø150	007-0156	biały	20	0,152	10,53
KR Ø150 B	007-0319	brązowy	20	0,152	11,87
KR Ø150 SP	007-0157	srebrny połysk	20	0,16	27,91
KR Ø150 SM	007-0570	srebrny mat	20	0,15	22,81
KR Ø150 ZM	007-0572	złoty mat	20	0,15	20,92

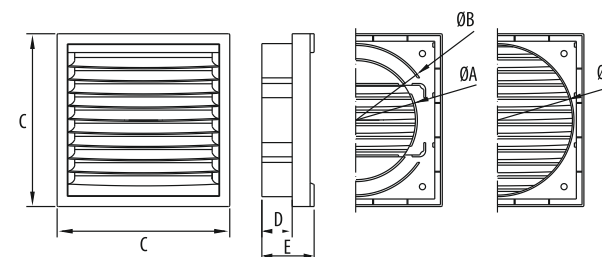

	A	B	C	D	E
KR Ø100/125	100	124	140	25	43
KR Ø150	149	-	176	33	52



TYP	INDEKS	KOLOR <sup>1</sup>	OPAKOWANIE ZBIORCZE	WAGA	CENA
jednostka			[szt.]	[kg]	[PLN]
KRŻ 100/125	007-0181	biały	20	0,096	7,43
KRŻ 100/125	007-0650	brązowy	20	0,1	8,94
KRŻ 150	007-0183	biały	20	0,118	11,71
KRŻ 150	007-0325	brązowy	20	0,12	13,68

	A	B	C	D	E
KRŻ Ø100/125	100	124	140	25	43
KRŻ Ø150	149	-	176	33	52

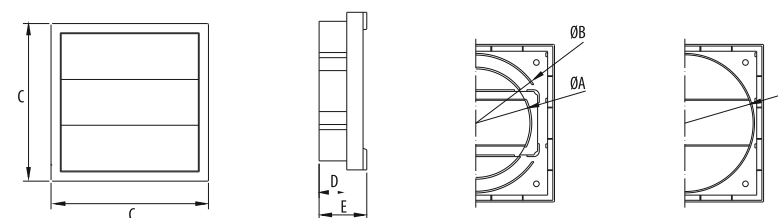

## RKŻ

KRATKA WENTYLACYJNA  
Z ŻALUZJĄ GRAWITACYJNA

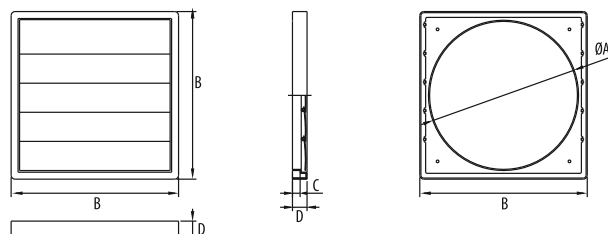

TYP	INDEKS	KOLOR <sup>1</sup>	OPAKOWANIE ZBIORCZE	WAGA	CENA
jednostka			[szt.]	[kg]	[PLN]
RKŻ □200	007-0402	szary	20	0,15	63,56
RKŻ □300	007-0403	szary	10	0,354	82,62
RKŻ □450	007-0404	szary	10	0,678	120,77

	A	B	C	D
RKŻ 200	170	200	9	20
RKŻ 300	267	300	10	26
RKŻ 450	428	460	10	26

## SMART

KRATKA WENTYLACYJNA -  
KWADRATOWA

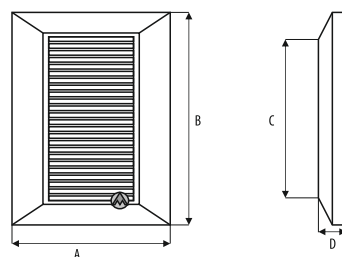

	A	B	C	D
SMART □ 135	174	174	132	17
SMART □ 165	202	202	161	17
SMART 90x240	139	280	238	17
SMART 140x210	172	248	205	17

TYP	INDEKS	KOLOR <sup>1</sup>	OPAKOWANIE ZBIORCZE	WAGA	CENA
jednostka			[szt.]	[kg]	[PLN]
SMART □ 135	007-4172	biały	20	0,08	4,84
SMART □ 165	007-4173	biały	20	0,112	5,55
SMART □ 135	007-4245	faktura drewna	20	0,1	15,57
SMART □ 165	007-4246	faktura drewna	20	0,114	16,69
SMART □ 135	007-4260	brązowy	20	0,08	5,81
SMART □ 165	007-4261	brązowy	20	0,112	6,67
SMART 90x240	007-4170	biały	20	0,106	5,44
SMART 140x210	007-4171	biały	20	0,118	5,85
SMART 90x240	007-4247	faktura drewna	20	0,11	16,69
SMART 140x210	007-4248	faktura drewna	20	0,138	16,69
SMART 90x240	007-4262	brązowy	20	0,106	6,54
SMART 140x210	007-4263	brązowy	20	0,118	7,03

TYP	INDEKS	KOLOR <sup>1</sup>	OPAKOWANIE ZBIORCZE	WAGA	CENA
jednostka			[szt.]	[kg]	[PLN]
DUO SMART □ 135	007-4176	biały	20	0,126	6,08
DUO SMART □ 165	007-4177	biały	20	0,166	7,24
DUO SMART Ø100	007-4178	biały	20	0,14	6,06
DUO SMART Ø125	007-4179	biały	20	0,128	6,19
DUO SMART Ø150	007-4180	biały	20	0,19	7,33
DUO SMART □ 135	007-4195	brązowy	20	0,126	8,04
DUO SMART □ 165	007-4265	brązowy	20	0,166	9,88
DUO SMART Ø100	007-4196	brązowy	20	0,14	8,00
DUO SMART Ø125	007-4197	brązowy	20	0,128	7,83
DUO SMART Ø150	007-4268	brązowy	20	0,19	9,27
DUO SMART □ 135	007-4234	faktura drewna	20	0,127	16,69
DUO SMART □ 165	007-4239	faktura drewna	20	0,168	17,80
DUO SMART Ø100	007-4235	faktura drewna	20	0,142	16,69
DUO SMART Ø125	007-4236	faktura drewna	20	0,13	17,80
DUO SMART Ø150	007-4240	faktura drewna	20	0,19	17,80
DUO SMART □ 135	007-4308	grafitowy	20	0,126	8,04
DUO SMART □ 135	007-4348	czarny	20	0,126	7,44

	A	B	C	D	E	F
DUO SMART □ 135	174	174	132	17	129	134
DUO SMART □ 165	202	202	161	17	159	164
DUO SMART Ø100	174	174	132	17	100	-
DUO SMART Ø125	174	174	132	17	125	-
DUO SMART Ø150	202	202	161	17	149	-

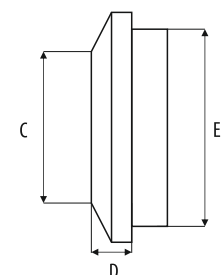
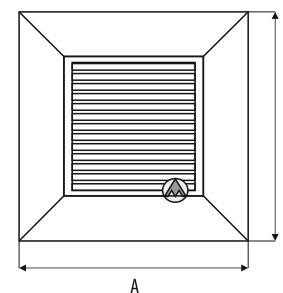

## DUO-SMART

KRATKA WENTYLACYJNA -  
PROSTOKĄTNA

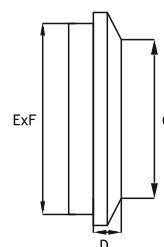
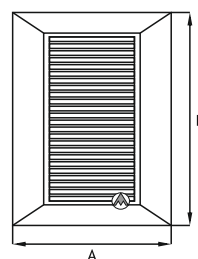

TYP	INDEKS	KOLOR <sup>1</sup>	OPAKOWANIE ZBIORCZE	WAGA	CENA
jednostka			[szt.]	[kg]	[PLN]
DUO SMART 90x240	007-4174	biały	20	0,16	6,36
DUO SMART 140x210	007-4175	biały	20	0,174	7,16
DUO SMART 90x240	007-4241	faktura drewna	20	0,18	17,80
DUO SMART 140x210	007-4237	faktura drewna	20	0,174	18,91
DUO SMART 140x210	007-4238	brązowy	20	0,174	9,17
DUO SMART 140x210	007-4359	grafitowy	20	0,162	9,17
DUO SMART 90x240	007-4264	brązowy	20	0,118	8,86

	A	B	C	D	E	F
DUO SMART 90x240	139	280	238	17	236	94
DUO SMART 140x210	172	248	205	17	202	128

## DL/RW

KRATKA WENTYLACYJNA -  
KWADRATOWA

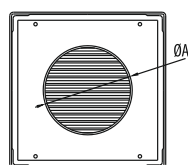
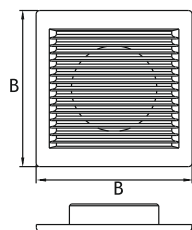

	A	B	C	D
DL Ø80 RW	80	175	23	33
DL Ø100 RW	99	175	23	33
DL Ø125 RW	124	175	23	33
DL Ø150 RW	147	204	25	35

TYP	INDEKS	KOLOR <sup>1</sup>	OPAKOWANIE ZBIORCZE	WAGA	CENA
jednostka			[szt.]	[kg]	[PLN]
DL Ø80 RW	007-1722	biały	20	0,142	8,66
DL Ø100 RW	007-0163	biały	20	0,134	8,79
DL Ø125 RW	007-0166	biały	20	0,126	9,04
DL Ø150 RW	007-0164	biały	20	0,176	10,07
DL Ø100 RW /B	007-4190	brązowy	20	0,134	9,85
DL Ø125 RW /B	007-4191	brązowy	20	0,126	10,12

TYP	INDEKS	KOLOR <sup>1</sup>	OPAKOWANIE ZBIORCZE	WAGA	CENA
jednostka			[szt.]	[kg]	[PLN]
DL/ 90x240 RW	007-0160	biały	20	0,16	9,17
DL/ 140x210 RW	007-0161	biały	20	0,15	10,18
DL/ 140x210 RW	007-4223	brązowy	20	0,15	11,47

	A	B	C	D	E	F
DL 90x240 RW	94	236	140	281	14	25
DL 140x210 RW	132	206	174	248	14	24

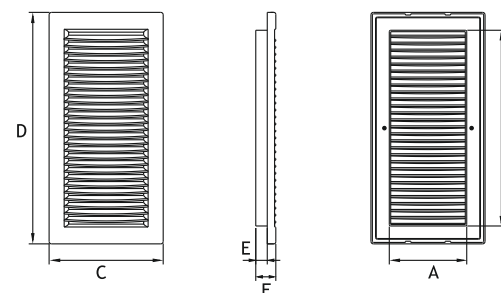

**DL/RW**  
KRATKA WENTYLACYJNA -  
PROSTOKATNA



TYP	INDEKS	KOLOR <sup>1</sup>	OPAKOWANIE ZBIORCZE	WAGA	CENA
jednostka			[szt.]	[kg]	[PLN]
DL/ □135 RW	007-0165	biały	20	0,124	6,24
DL/ □165 RW	007-0162	biały	20	0,154	7,78
DL/ □135 RW /B	007-4192	brązowy	20	0,124	9,84

	A	B	C	D
DL/ □135 RW	134	175	15	25
DL/ □165 RW	164	205	17	28

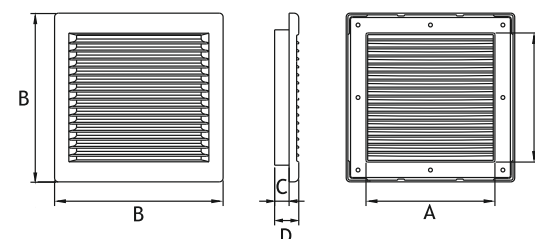

**DL/RW**  
KRATKA WENTYLACYJNA -  
KWADRATOWA

**D/W**  
KRATKA WENTYLACYJNA -  
PROSTOKĄTNA

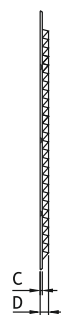
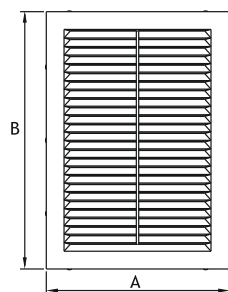

TYP	INDEKS	KOLOR <sup>1</sup>	OPAKOWANIE ZBIORCZE	WAGA	CENA
jednostka			[szt.]	[kg]	[PLN]
D/ 170x240 W	007-0171	biały	20	0,102	5,35

	A	B	C	D
D/ 170x240 W	170	240	2	8

**D/W**  
KRATKA WENTYLACYJNA -  
PROSTOKĄTNA

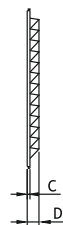
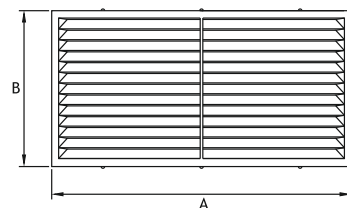

TYP	INDEKS	KOLOR <sup>1</sup>	OPAKOWANIE ZBIORCZE	WAGA	CENA
jednostka			[szt.]	[kg]	[PLN]
D/ 220x120 W	007-0173	biały	20	0,052	6,62

	A	B	C	D
D/ 220x120 W	217	113	2	8

TYP	INDEKS	KOLOR <sup>1</sup>	OPAKOWANIE ZBIORCZE	WAGA	CENA
jednostka			[szt.]	[kg]	[PLN]
D/ 140 W	007-0169	biały	20	0,06	4,20
D/ 195 W	007-0175	biały	20	0,092	5,44
D/ 235 W	007-0177	biały	20	0,118	9,41
D/ 195 W/B	007-0182	brązowy	20	0,09	7,45

	A	B	C
D/ 140 W	137	2	8
D/ 195 W	194	2	8
D/ 235 W	234	2	8

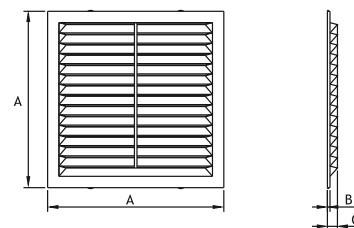

**D/W**  
KRATKA WENTYLACYJNA - KWADRATOWA



TYP	INDEKS	KOLOR <sup>1</sup>	OPAKOWANIE ZBIORCZE	WAGA	CENA
jednostka			[szt.]	[kg]	[PLN]
D/ 180x250 RW	007-0172	biały	20	0,174	6,29

	A	B	C	D
D/ 180x250 RW	184	254	10	16

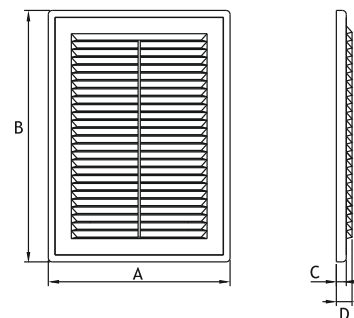

**D/RW**  
KRATKA WENTYLACYJNA - PROSTOKĄTNA



**D/RW**  
KRATKA WENTYLACYJNA -  
PROSTOKĄTNA

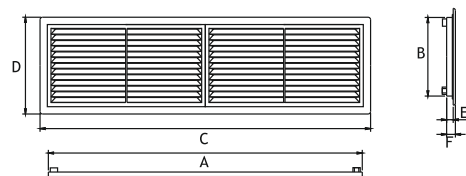

TYP	INDEKS	KOLOR <sup>1</sup>	OPAKOWANIE ZBIORCZE	WAGA	CENA
jednostka			[szt.]	[kg]	[PLN]
D/ 430x110 RW	007-0174	biały	20	0,16	14,80

	A	B	C	D	E	F
D/ 430x110 RW	429	108	453	132	9	12

**D/RW**  
KRATKA WENTYLACYJNA -  
PROSTOKĄTNA

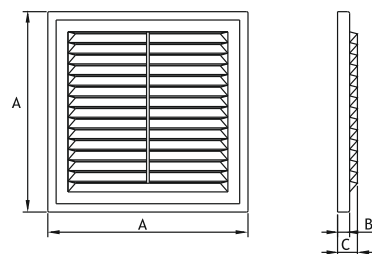

TYP	INDEKS	KOLOR <sup>1</sup>	OPAKOWANIE ZBIORCZE	WAGA	CENA
jednostka			[szt.]	[kg]	[PLN]
D/ 150 RW	007-0170	biały	20	0,09	4,58
D/ 210 RW	007-0176	biały	20	0,174	10,82
D/ 250 RW	007-0178	biały	20	0,202	13,65

	A	B	C
D/ 150 RW	149	9	15
D/ 210 RW	208	10	16
D/ 250 RW	249	10	17

TYP	INDEKS	KOLOR <sup>1</sup>	OPAKOWANIE ZBIORCZE	WAGA	CENA
jednostka			[szt.]	[kg]	[PLN]
D/14 OW Ø100	007-0159	biały	20	0,152	9,56
D/14 OW Ø125	007-0663	biały	20	0,12	11,34

	A	B	C	D	E	F	G	H	J	K	L
D/14 OW Ø100	105	140	212	108	250	180	137	29	23	75	50
D/14 OW Ø125	130	140	211	133	250	180	137	30	22	65	49

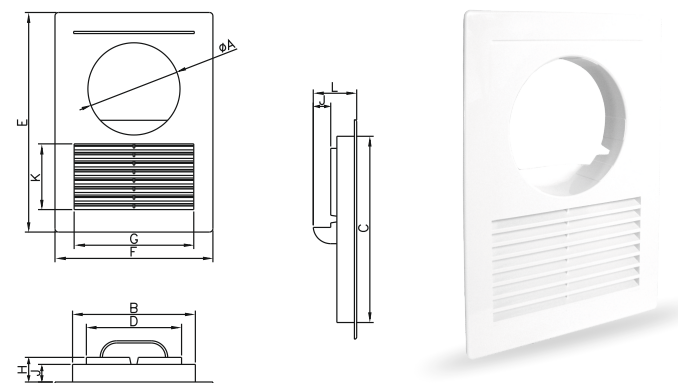

**D14/OW**  
KRATKA WENTYLACYJNA -  
PROSTOKATNA

TYP	INDEKS	KOLOR <sup>1</sup>	OPAKOWANIE ZBIORCZE	WAGA	CENA
jednostka			[szt.]	[kg]	[PLN]
BELLA Ø100	007-1023	biały	20	0,034	2,40
BELLA Ø100 /B	007-1020	brązowy	20	0,034	3,65
BELLA Ø125	007-1024	biały	20	0,052	3,61
BELLA Ø125 /B	007-1021	brązowy	20	0,052	4,95
BELLA Ø150	007-1025	biały	20	0,072	4,69
BELLA Ø150 /B	007-1022	brązowy	20	0,072	6,02

	A	B	C	D
DOSPEL BELLA Ø100	99	23	26	134
DOSPEL BELLA Ø125	124	27	30	160
DOSPEL BELLA Ø150	149	34	37	184



**BELLA**  
KRATKA WENTYLACYJNA -  
OKRĄGŁA

**KRD**  
KRATKA WENTYLACYJNA  
Z PRZEPUSTNICĄ

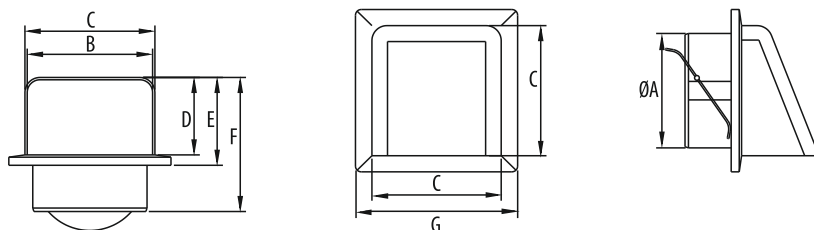

TYP	INDEKS	KOLOR <sup>1</sup>	OPAKOWANIE ZBIORCZE	WAGA	CENA
jednostka			[szt.]	[kg]	[PLN]
KRD Ø100	007-0201	biały	10	0,128	11,57
KRD Ø100 /B	007-0317	brązowy	10	0,126	12,73
KRD Ø100 /G	007-4358	grafitowy	10	0,126	12,73

	A	B	C	D	E	F	G
KRD Ø100	99	106	112	68	79	116	140

**KZP**  
KRATKA WENTYLACYJNA -  
PROSTOKĄTNA/ZEWNETRZNA

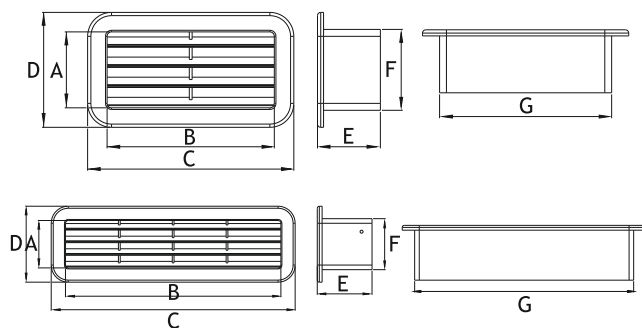

TYP	INDEKS	KOLOR <sup>1</sup>	OPAKOWANIE ZBIORCZE	WAGA	CENA
jednostka			[szt.]	[kg]	[PLN]
KZP 110x55	007-1511	biały	20	0,036	3,74
KZP 220x55	007-1512	biały	20	0,114	9,23

	A	B	C	D	E	F	G
KZP 110x55	49	105	127	71	39	50	106

	A	B	C	D	E	F	G
KZP 220x55	49	214	240	75	54	50	216

TYP	INDEKS	KOLOR <sup>1</sup>	OPAKOWANIE ZBIORCZE	WAGA	CENA
jednostka			[szt.]	[kg]	[PLN]
KOS Ø100	007-0426	biały	20	0,098	5,23
KOS Ø125	007-0427	biały	20	0,11	6,76
KOS Ø150	007-0428	biały	20	0,176	8,50

	A	B	C	D
KOS Ø100	99	58	68	144
KOS Ø125	124	62	72	164
KOS Ø150	149	65	74	188

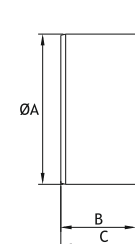
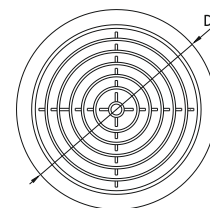

**KOS**  
KRATKA WENTYLACYJNA -  
SUFITOWA

TYP	INDEKS	KOLOR <sup>1</sup>	OPAKOWANIE ZBIORCZE	WAGA	CENA
jednostka			[szt.]	[kg]	[PLN]
KKS Ø80	007-1721	biały	20	0,151	8,92
KKS Ø100	007-0429	biały	20	0,142	7,52
KKS Ø125	007-0430	biały	20	0,136	10,07
KKS Ø150	007-0432	biały	20	0,202	13,88
KKS □135	007-0431	biały	20	0,14	11,34
KKS □165	007-0433	biały	20	0,178	12,61

	A	B	C	D	E
KKS Ø80	79	174	23	35	-
KKS Ø100	99	174	23	35	-
KKS Ø125	124	174	23	35	-
KKS Ø150	148	203	25	37	-
KKS □135	-	174	15	27	134
KKS □165	-	204	18	30	164

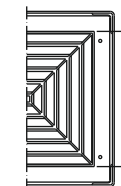
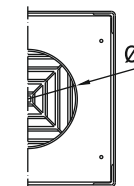
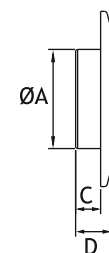
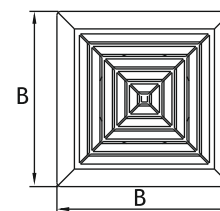
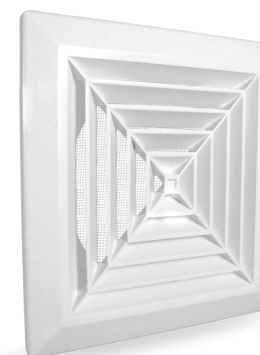

**KKS**  
KRATKA WENTYLACYJNA -  
SUFITOWA

## D/AKO

KRATKA ALUMINIOWA - OKRĄGŁA

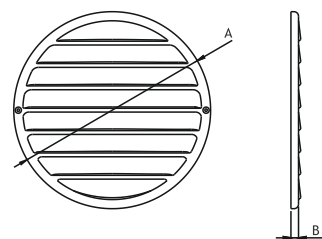

TYP	INDEKS	KOLOR	OPAKOWANIE ZBIORCZE	WAGA	CENA
jednostka			[szt.]	[kg]	[PLN]
D/AKO 130	007-0197	biały	50	0,023	15,20
D/AKO 130 /AZ	007-0548	antyk-złoto	50	0,024	16,39
D/AKO 130 /AS	007-0547	antyk-srebro	50	0,024	16,39
D/AKO 130 /B	007-0648	brązowy	50	0,024	16,39
D/AKO 130 /AL	007-1235	aluminium	50	0,023	10,89

	A	B
D/AKO Ø130	127	5

## D/AKP

KRATKA ALUMINIOWA - PROSTOKĄTNA

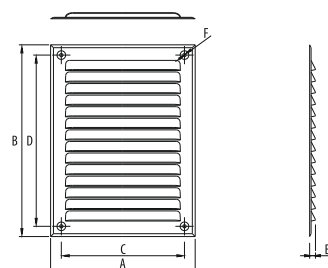

TYP	INDEKS	KOLOR	OPAKOWANIE ZBIORCZE	WAGA	CENA
jednostka			[szt.]	[kg]	[PLN]
D/AKP 150x200	007-0196	biały	50	0,058	13,51
D/AKP 150x200 /B	007-0649	brązowy	50	0,054	14,83
D/AKP 175x250	007-0440	aluminium/biały	50	0,046	17,07
D/AKP 175x250 /B	007-0651	brązowy	50	0,054	19,17
D/AKP 150x200 /AL	007-1236	aluminium	50	0,054	9,42
D/AKP 150x200 /AS	007-0541	antyk-srebro	50	0,058	16,69
D/AKP 150x200 /AZ	007-0539	antyk-złoto	50	0,054	11,74
D/AKP 175x250 /AL	007-1237	aluminium	50	0,046	18,61
D/AKP 175x250 /AS	007-0542	al.antyk-srebro	50	0,054	17,34
D/AKP 175x250 /AZ	007-0540	antyk-złoto	50	0,054	14,16

	A	B	C	D	E	F
D/AKP 150x200	150	200	128	178	6	3,5
D/AKP 175x250	175	250	148	221	6	4

TYP	INDEKS	KOLOR	OPAKOWANIE ZBIORCZE	WAGA	CENA
jednostka			[szt.]	[kg]	[PLN]
D/ AKK □150	007-0193	biały	50	0,04	9,81
D/ AKK □150 /B	007-0645	brązowy	50	0,04	14,83
D/ AKK □150 /A-S	007-0545	antyk-srebro	50	0,034	14,83
D/ AKK □175	007-0441	biały	50	0,058	14,95
D/ AKK □175 /B	007-0646	brązowy	50	0,054	16,43
D/ AKK □175 /A-S	007-0546	antyk-srebro	50	0,048	16,43

	A	B	C	D
D/ AKK □150	150	128	6	3,5
D/ AKK □175	175	149	6	3,5

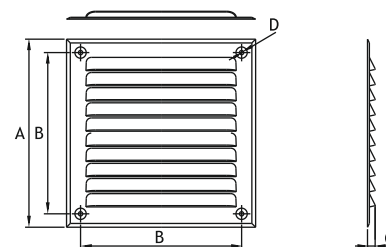

**D/AKK**  
KRATKA ALUMINIOWA - KWADRATOWA

TYP	INDEKS	KOLOR <sup>1</sup>	OPAKOWANIE ZBIORCZE	WAGA	CENA
jednostka			[szt.]	[kg]	[PLN]
KD 90x445	007-1490	biały	10	0,498	13,88
KD 70x450	007-1491	biały	10	0,324	19,59
KD 90x445	007-4210	brązowy	10	0,46	16,65
KD 70x450	007-4211	brązowy	10	0,304	23,51
KD 70x450	007-4298	drewno	10	0,308	35,66
KD 90x445	007-4299	drewno	10	0,454	30,32

	A	B	C	D	E	F	G	H
KD 90x445	92	433	462	136	33	37	121	443
KD 70x450	68	441	464	90	33	37	79	449

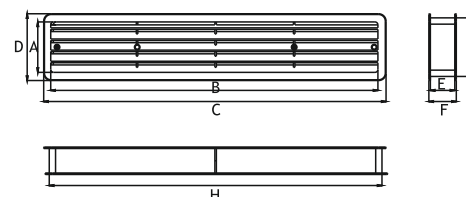

**KD**  
KRATKA WENTYLACYJNA - DRZWIOWA

## NKM

KRATKA KWADRATOWA  
Z ŻALUZJĄ

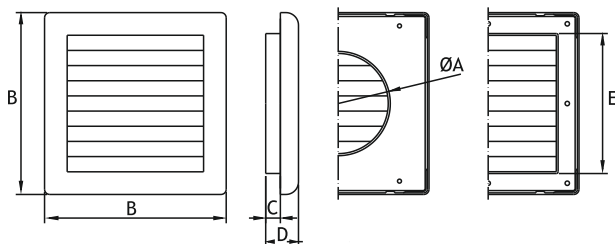

TYP	INDEKS	KOLOR <sup>1</sup>	OPAKOWANIE ZBIORCZE	WAGA	CENA
jednostka			[szt.]	[kg]	[PLN]
NKM Ø80	007-1739	biały	20	0,2	9,48
NKM Ø100	007-1740	biały	20	0,118	10,07
NKM Ø125	007-1741	biały	20	0,178	11,34
NKM □135	007-1742	biały	20	0,168	12,61

	A	B	C	D	E
NKM Ø80	79	174	23	41	-
NKM Ø100	99	174	23	41	-
NKM Ø125	124	174	23	41	-
NKM □135	-	174	15	33	134

## D/15 WR

KRATKA WENTYLACYJNA  
Z ŻALUZJĄ MECHANICZNĄ

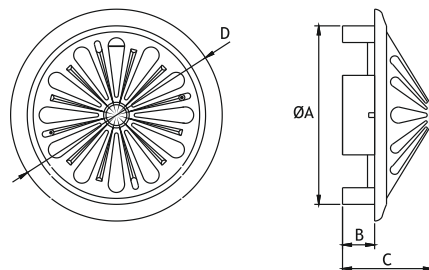

TYP	INDEKS	KOLOR <sup>1</sup>	OPAKOWANIE ZBIORCZE	WAGA	CENA
jednostka			[szt.]	[kg]	[PLN]
D/15 WR	007-0271	biały	20	0,136	9,42

	A	B	C	D
D/15 WR	80-160	27	76	178

TYP	INDEKS	KOLOR	OPAKOWANIE ZBIORCZE	WAGA	CENA
jednostka			[szt.]	[kg]	[PLN]
D/TKM 140x140 /B	007-1816	brązowy	15	0,37	12,27
D/TKM 140x140 /N	007-1822	srebrny	15	0,364	22,14
D/TKM 140x210 /B	007-1818	brązowy	15	0,458	13,47
D/TKM 140x210 /N	007-1823	srebrny	15	0,456	26,15

	A	B
D/TKM 140x140	140	140
D/TKM 140x210	140	210

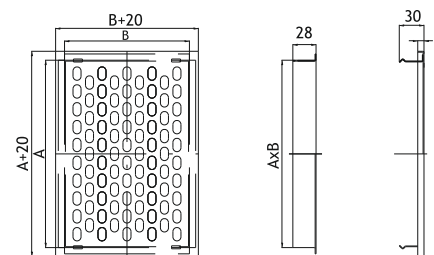

**D/TKM**  
KRATKA METALOWA ŚCIENNA  
DO WEWNĄTRZ

TYP	INDEKS	KOLOR	OPAKOWANIE ZBIORCZE	WAGA	CENA
jednostka			[szt.]	[kg]	[PLN]
D/AK 140x140 /B	007-1824	brązowy	15	0,414	17,74
D/AK 140x140 GRAFIT	007-4405	grafitowy	15	0,438	17,74
D/AK 140x140 /N	007-1820	srebrny	15	0,41	26,15
D/AK 140x210 /B	007-1825	brązowy	15	0,558	19,34
D/AK 140x210 GRAFIT	007-4406	grafitowy	15	0,534	19,34
D/AK 140x210 /N	007-1821	srebrny	15	0,54	30,41
D/AK 110x140	007-4330	brązowy	15	0,362	17,74
D/AK 110x140 GRAFIT	007-4407	grafitowy	15	0,362	17,74
D/AK 110x140	007-4331	czarny	15	0,362	17,74

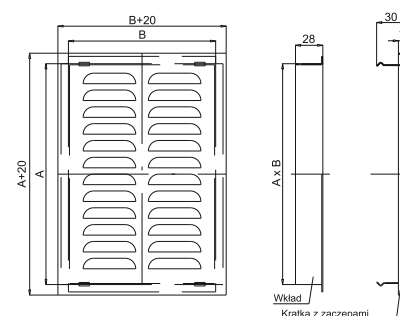

	A	B
D/AK 140x140	140	140
D/AK 140x210	140	210



**D/AK**  
KRATKA METALOWA ŚCIENNA  
NA ZEWNĄTRZ





TYP	INDEKS	KOLOR <sup>1</sup>	OPAKOWANIE ZBIORCZE	WAGA	CENA
jednostka			[szt.]	[kg]	[PLN]
D/TK 140	007-1567	biały	20	0,09	3,97
D/TK 140 /B	007-1569	brązowy	20	0,096	4,49
D/TK 140x210	007-1650	biały	20	0,096	4,80
D/TK 140x210 /B	007-1652	brązowy	20	0,098	6,62

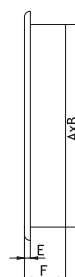
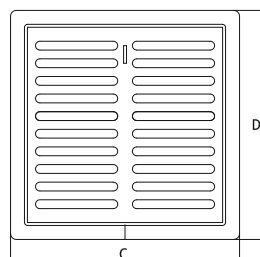

TYP	INDEKS	KOLOR <sup>1</sup>	OPAKOWANIE ZBIORCZE	WAGA	CENA
jednostka			[szt.]	[kg]	[PLN]
D/TKŻ 140	007-1568	biały / z żaluzją	20	0,114	5,53
D/TKŻ 140 /B	007-1570	brązowy / z żaluzją	20	0,116	6,02
D/TKŻ 140x210	007-1651	biały / z żaluzją	20	0,096	6,02
D/TKŻ 140x210 /B	007-1653	brązowy / z żaluzją	20	0,126	7,25

	A	B	C	D	E	F
D/TK D/TKŻ 140	138	138	156	156	4	27
D/TK D/TKŻ 140x210	208	138	156	226	4	27

TYP	INDEKS	KOLOR <sup>1</sup>	OPAKOWANIE ZBIORCZE	WAGA	CENA
jednostka			[szt.]	[kg]	[PLN]
IMPERIO Ø80	007-1764	biały	20	0,2	8,88
IMPERIO Ø80 /B	007-1743	brązowy	20	0,196	11,86
IMPERIO Ø100	007-1765	biały	20	0,172	8,91
IMPERIO Ø100 /B	007-1744	brązowy	20	0,176	17,77
IMPERIO Ø125	007-1766	biały	20	0,172	11,87
IMPERIO Ø125 /B	007-1745	brązowy	20	0,172	18,36
IMPERIO □135	007-1767	biały	20	0,158	11,34
IMPERIO □135 /B	007-1746	brązowy	20	0,156	18,04
IMPERIO 140x210	007-1781	biały	20	0,214	12,55

**IMPERIO**  
KRATKA WENTYLACYJNA  
Z ŻALUZJĄ MECHANICZNĄ



IMPERIO 140x210

	A	B	C	D	E	F	G
IMPERIO Ø80	174	174	23	39	-	-	79
IMPERIO Ø100	174	174	23	39	-	-	99
IMPERIO Ø125	174	174	23	39	-	-	124
IMPERIO □135	174	174	15	31	134	134	-

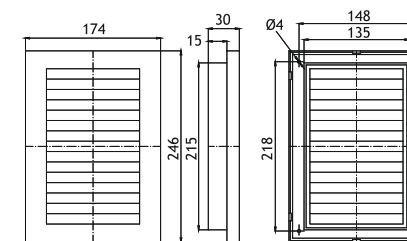
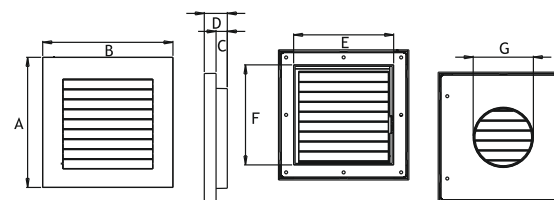

## DR/KOM

DRZWIČKI REWIZYJNE -  
KOMINKOWE

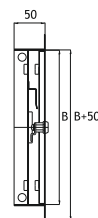
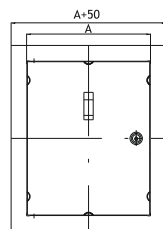

TYP	INDEKS	KOLOR	OPAKOWANIE ZBIORCZE	WAGA	CENA
jednostka			[szt.]	[kg]	[PLN]
DR/KOM 140x140	007-1800	biały	20	0,788	19,01
DR/KOM 140x140 /B	007-1812	brązowy	20	0,788	20,43
DR/KOM 140x140 /N	007-1813	srebrny	20	0,766	35,64
DR/KOM 150x250	007-1801	biały	20	1,275	24,24
DR/KOM 150x250 /B	007-1814	brązowy	20	1,28	26,25
DR/KOM 150x250 /N	007-1815	srebrny	20	1,202	48,47

/N wykonanie w wersji nierdzewnej

	A	B
DR/KOM 140x140	140	140
DR/KOM 150x250	150	250

## AN

ANEMOSTAT Z TWORZYWA,  
NAWIEWNO - WYWIEWNY

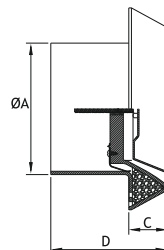
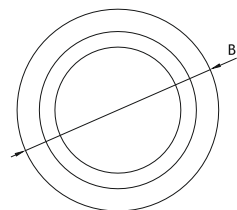

TYP	INDEKS	KOLOR	OPAKOWANIE ZBIORCZE	WAGA	CENA
jednostka			[szt.]	[kg]	[PLN]
AN Ø100	007-0198	biały	20	0,188	10,55
AN Ø125	007-0199	biały	20	0,236	11,82
AN Ø150	007-0200	biały	20	0,304	14,15

	A	B	C	D
AN Ø100	99	152	21	80
AN Ø125	124	163	23	80
AN Ø150	148	193	21	80

TYP	INDEKS	KOLOR	OPAKOWANIE ZBIORCZE	WAGA	CENA
jednostka			[szt.]	[kg]	[PLN]
MAGNAT 150x200 /M	007-1796	biały	10	0,928	26,26
MAGNAT 200x200 /M	007-1791	biały	10	0,67	29,86
MAGNAT 200x250 /M	007-1797	biały	10	1,228	32,85
MAGNAT 200x300 /M	007-1798	biały	10	21,360	35,85
MAGNAT 250x300 /M	007-1799	biały	10	1,534	38,85
MAGNAT 300x300 /M	007-1792	biały	10	2,39	40,65
MAGNAT 400x400 /M	007-1793	biały	5	3,65	59,83
MAGNAT 500x500 /M	007-1794	biały	5	5,15	80,21
MAGNAT 600x600 /M	007-1795	biały	5	6,58	104,19
MAGNAT 150x200 /ZN	007-1845	srebrny	10	0,64	56,11
MAGNAT 200x200 /ZN	007-1849	srebrny	10	0,96	63,31
MAGNAT 200x250 /ZN	007-1846	srebrny	10	0,846	69,30
MAGNAT 200x300 /ZN	007-1847	srebrny	10	1,22	75,30
MAGNAT 250x300 /ZN	007-1848	srebrny	10	1,48	81,29
MAGNAT 300x300 /ZN	007-1850	srebrny	10	1,63	84,89
MAGNAT 400x400 /ZN	007-1851	srebrny	5	2,535	123,26
MAGNAT 500x500 /ZN	007-1852	srebrny	5	3,41	164,02
MAGNAT 600x600 /ZN	007-1853	srebrny	5	3,57	211,98
MAGNAT 150x200 /N	007-1807	srebrny	10	0,63	52,52
MAGNAT 200x200 /N	007-1802	srebrny	10	0,98	59,71
MAGNAT 200x250 /N	007-1808	srebrny	10	1,086	65,71
MAGNAT 200x300 /N	007-1809	srebrny	10	1,234	71,70
MAGNAT 250x300 /N	007-1810	srebrny	10	1,38	77,70
MAGNAT 300x300 /N	007-1803	srebrny	10	1,61	81,29
MAGNAT 400x400 /N	007-1804	srebrny	5	2,51	119,66
MAGNAT 500x500 /N	007-1805	srebrny	5	3,355	160,43
MAGNAT 600x600 /N	007-1806	srebrny	5	3,569	208,39
MAGNAT 150x200 /Z	007-1836	biały	10	0,93	29,86
MAGNAT 200x200 /Z	007-1840	biały	10	0,69	33,45
MAGNAT 200x250 /Z	007-1837	biały	10	1,125	36,45
MAGNAT 200x300 /Z	007-1838	biały	10	1,34	39,45
MAGNAT 250x300 /Z	007-1839	biały	10	1,834	42,44
MAGNAT 300x300 /Z	007-1841	biały	10	2,42	44,24
MAGNAT 400x400 /Z	007-1842	biały	5	23,650	63,43
MAGNAT 500x500 /Z	007-1843	biały	5	5,185	83,81
MAGNAT 600x600 /Z	007-1844	biały	5	6,65	107,79

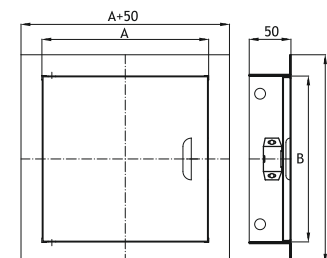

	A	B
MAGNAT 150x200	150	200
MAGNAT 200x200	200	200
MAGNAT 200x250	200	250
MAGNAT 200x300	200	300
MAGNAT 250x300	250	300
MAGNAT 300x300	300	300
MAGNAT 400x400	400	400
MAGNAT 500x500	500	500
MAGNAT 600x600	600	600

/M - wersja z zamkiem magnetycznym

/N - wykonanie nierdzewne z zamkiem magnetycznym

/Z - wersja z kluczem

/ZN - wykonanie nierdzewne z kluczykiem

**DR**  
DRZWICZKI REWIZYJNE

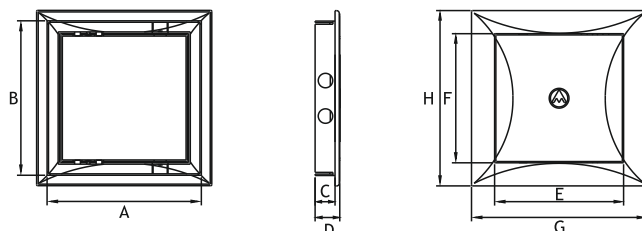

DR	A	B	C	D	E	F	G	H
150x150	147	147	19	24	123	123	167	167
150x200	148	197	19	24	123	173	167	217
150x300	147	296	19	24	123	272	167	317
200x200	197	197	19	24	272	272	217	217
200x250	197	247	19	24	173	223	217	266
200x300	247	247	19	24	223	223	267	267
250x250	197	296	19	24	173	272	217	316
250x300	247	296	19	24	223	272	267	317
300x300	296	296	19	24	272	272	316	316
300x400	295	396	19	24	271	371	316	415

TYP	INDEKS	KOLOR <sup>1</sup>	OPAKOWANIE ZBIORCZE	WAGA	CENA
jednostka			[szk.]	[kg]	[PLN]
DR 150x150	007-1241	biały	20	0,086	9,35
DR 150x200	007-1242	biały	20	0,118	10,40
DR 150x300	007-4214	biały	20	0,157	14,60
DR 200x200	007-1243	biały	20	0,146	14,50
DR 200x250	007-1244	biały	20	0,174	15,65
DR 200x300	007-1245	biały	20	0,206	18,80
DR 250x250	007-4213	biały	20	0,309	17,75
DR 250x300	007-4215	biały	20	0,233	19,85
DR 300x300	007-1247	biały	20	0,294	20,90
DR 300x400	007-1248	biały	20	0,35	24,05
DR 150x150	007-4224	faktura drewna	20	0,088	19,00
DR 150x200	007-4225	faktura drewna	20	0,12	21,00
DR 150x300	007-4226	faktura drewna	20	0,159	23,00
DR 200x200	007-4227	faktura drewna	20	0,148	23,00
DR 200x250	007-4228	faktura drewna	20	0,176	25,00
DR 200x300	007-4229	faktura drewna	20	0,208	28,00
DR 250x250	007-4230	faktura drewna	20	0,314	27,00
DR 250x300	007-4231	faktura drewna	20	0,235	29,00
DR 300x300	007-4232	faktura drewna	20	0,294	30,00
DR 300x400	007-4233	faktura drewna	20	0,35	33,00
DR 150x150	007-4269	brązowy	20	0,086	11,22
DR 150x200	007-4270	brązowy	20	0,116	12,48
DR 150x300	007-4266	brązowy	20	0,159	17,52
DR 200x200	007-4271	brązowy	20	0,146	17,50
DR 200x250	007-4272	brązowy	20	0,174	18,78
DR 200x300	007-4273	brązowy	20	0,206	22,56
DR 250x250	007-4274	brązowy	20	0,314	21,30
DR 250x300	007-4275	brązowy	20	0,235	23,82
DR 300x300	007-4276	brązowy	20	0,294	25,08
DR 300x400	007-4277	brązowy	20	0,35	28,86

TYP	INDEKS	KOLOR	OPAKOWANIE ZBIORCZE	WAGA	CENA
jednostka			[szt.]	[kg]	[PLN]
ANM Ø80 /N	012-0549	biały	10	0,202	10,88
ANM Ø100 /N	012-0202	biały	10	0,256	15,75
ANM Ø125 /N	012-0203	biały	10	0,346	18,90
ANM Ø150 /N	012-0550	biały	10	0,518	23,84
ANM Ø160 /N	012-0287	biały	10	0,494	24,10
ANM Ø200 /N	012-0288	biały	10	0,706	35,60
ANM Ø250 /N	012-0720	biały	10	0,956	55,04
ANM Ø80 /W	012-8046	biały	10	0,202	10,88
ANM Ø100 /W	012-8047	biały	10	0,252	15,65
ANM Ø125 /W	012-8048	biały	10	0,344	18,80
ANM Ø150 /W	012-8049	biały	10	0,512	25,10
ANM Ø160 /W	012-8050	biały	10	0,488	26,15
ANM Ø200 /W	012-8051	biały	10	0,654	35,60
ANM Ø250 /W	012-8052	biały	10	0,856	62,90
ANMN Ø100 /N	012-1108	srebrny	10	0,246	40,83
ANMN Ø125 /N	012-1109	srebrny	10	0,32	44,84
ANMN Ø150 /N	012-1110	srebrny	10	0,474	58,82
ANMN Ø160 /N	012-1111	srebrny	10	0,572	61,24
ANMN Ø200 /N	012-1112	srebrny	10	0,778	72,83

N - nawiewny  
W - wyciewny



**ANM/ANMN**  
ANEMOSTAT METALOWY

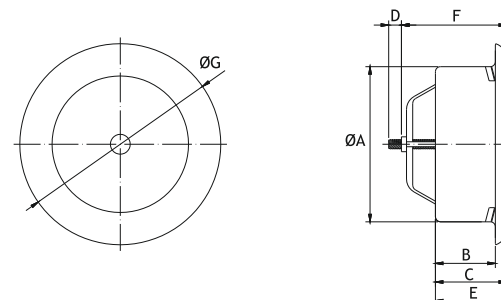

	A	B	C	D	E	F	G
ANM Ø80	80	46	53	0-19	53-81	53	116
ANM Ø100	99	48	57	0-26	53-70	52	138
ANM Ø125	124	47	57	0-43	54-84	57	165
ANM Ø150	149	46	59	0-39	56-88	65	200
ANM Ø160	159	46	55	0-41	55-83	66	210
ANM Ø200	198	46	59	0-51	56-92	72	252
ANM Ø250 /N	248	42	50	0-51	56-94	99	303

## RD 40

ROZETY DRZWIOWE

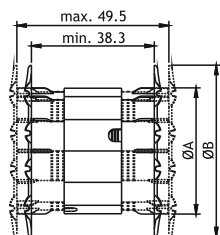
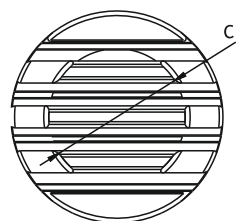

TYP	INDEKS	KOLOR	OPAKOWANIE ZBIORCZE	WAGA	CENA
jednostka			[szt.]	[kg]	[PLN]
RD 40	007-0696	biały	20	0,03	4,87
RD 40 /C-BZ	007-0699	ciemny beżowy	20	0,03	4,87
RD 40 /BZ	007-0697	beżowy	20	0,03	4,87
RD 40 /Z	007-0700	złoty	20	0,03	11,35
RD 40 /S	007-0701	srebrny	20	0,03	11,35
RD 40 /B	007-0702	brązowy	20	0,03	6,12
RD 40 /H	007-4303	drewno	20	0,032	9,13

	A	B	C
RD 40	38,5	53	33

## COLT

NASADA KIMINOWA OBROTOWA

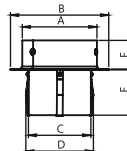
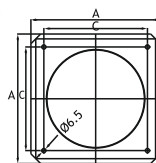
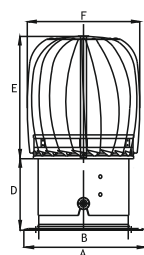

Redukcja podstawy COLT

TYP	INDEKS	KOLOR	OPAKOWANIE ZBIORCZE	WAGA	CENA
jednostka			[szt.]	[kg]	[PLN]
COLT Ø150	007-1733	srebrny	1	1,634	143,00

	A	B	C	D	E	F
COLT Ø150	200	150	160	118	~210	190

	A	B	C	D	E	F	INDEKS	CENA [PLN]
COLT z redukcją Ø150/100	148	200	98	99,6-105	95	50	007-4391	151,00
COLT z redukcją Ø150/125	148	200	123	124,6-130	95	50	007-4392	159,00
COLT z redukcją Ø150/150	148	200	148	149,6-155	95	54	007-4401	170,00

TYP	INDEKS	KOLOR	OPAKOWANIE ZBIORCZE	WAGA	CENA
jednostka			[szt.]	[kg]	[PLN]
TRN Ø150	007-0148	srebrny	1	1,838	131,25
TRN Ø150 /B	007-0149	brązowy	1	1,936	141,75
TRN Ø200	007-0417	srebrny	1	2,686	197,40
TRN Ø200 /B	007-0418	brązowy	1	2,398	207,90
TRN Ø300	007-4360	srebrny	1	4,284	319,00

	A	B	C	D	E
TRN Ø150	146	248	110	205	254
TRN Ø200	196	330	115	245	314
TRN Ø300	300	450	110	340	440

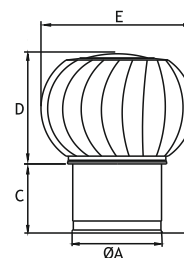
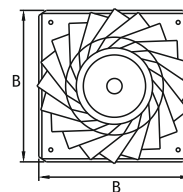

**TRN**  
NASADA KOMINOWA  
OBROTOWA

TYP	INDEKS	KOLOR	OPAKOWANIE ZBIORCZE	WAGA	CENA
jednostka			[szt.]	[kg]	[PLN]
TWIST Ø160	007-0419	srebrny	1	1,916	92,40
TWIST Ø160 /CH-N	007-0471	srebrny	1	1,992	207,90
TWIST Ø200	007-0420	srebrny	1	2,534	102,90
TWIST Ø200 /CH-N	007-0472	srebrny	1	2,592	250,95

CH-N- chrom-nikiel

	A	B	C	D
TWIST Ø160	155	255	20	406
TWIST Ø200	200	305	20	486

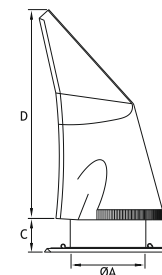
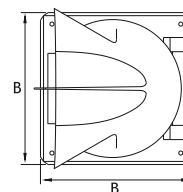

**TWIST**  
SAMONASTAWIANA  
NASADA KOMINOWA



## RADON FREE

MODUŁ CZERPNI DO GWC  
BEZPRZEPONOWYCH

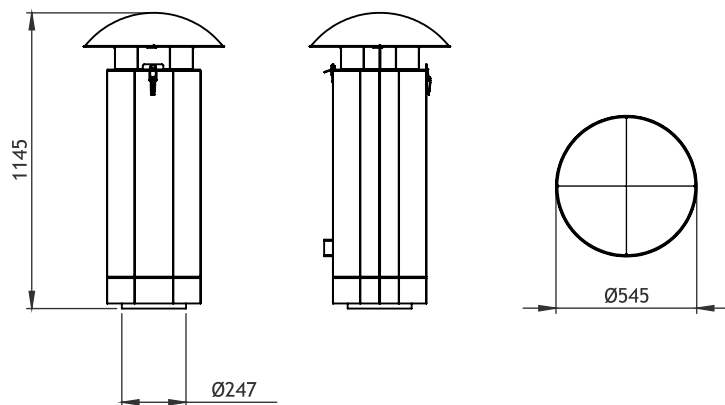

TYPE	INDEKS	KOLOR	OPAKOWANIE ZBIORCZE	WEIGHT	CENA
jednostka			[szt.]	[kg]	[PLN]
MODUŁ RADON FREE	700-7606	srebrny/brązowy	1	24	8700

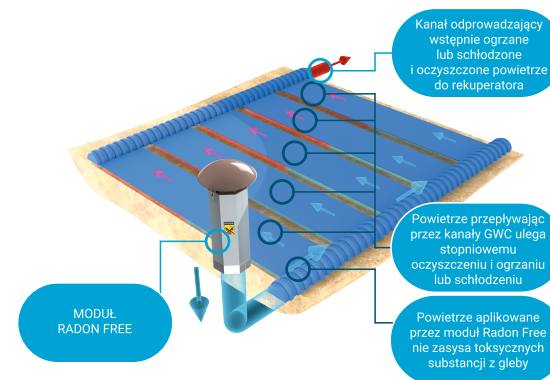

Przykład montażu z domowej instalacji wentylacyjnej