

TYP	INDEKS	KOLOR	OPAKOWANIE ZBIORCZE	WAGA	CENA
jednostka			[szt.]	[kg]	[PLN]
D/ŁP 110x55	007-0220	biały	20	0,044	3,33
D/ŁP 220x55	007-1481	biały	20	0,08	6,20

	A	B	C	D	E
D/ŁP 110x55	110	55	113	58	74
D/ŁP 220x55	220	55	223	58	68

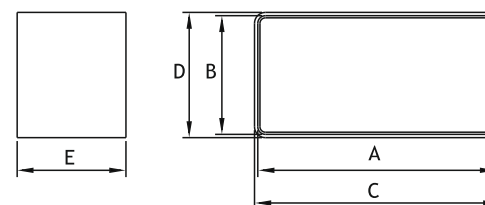

**D/ŁP**  
ŁĄCZNIK KANAŁÓW  
PŁASKICH

TYPE	INDEKS	KOLOR	OPAKOWANIE ZBIORCZE	WAGA	CENA
jednostka			[szt.]	[kg]	[PLN]
D/ŁPP 110x55	007-0306	biały	20	0,044	4,47

	A	B	C	D	E
D/ŁPP 110x55	110	55	113	58	50

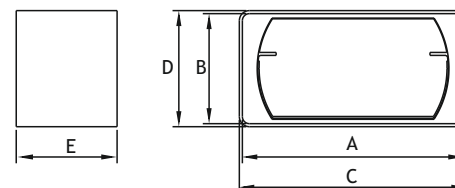

**D/ŁPP**  
ŁĄCZNIK KANAŁÓW  
PŁASKICH  
Z PRZEPUSTNICĄ

## D/KŁZ

KOLANO ŁĄCZNIKOWE ZMIENNE

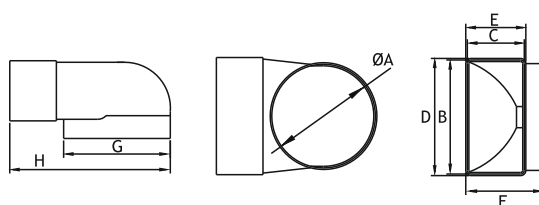

TYP	INDEKS	KOLOR	OPAKOWANIE ZBIORCZE	WAGA	CENA
jednostka			[szt.]	[kg]	[PLN]
D/KŁZ Ø104/110x55	007-0223	biały	20	0,088	6,19
D/KŁZ Ø125/220x55	007-1477	biały	20	0,262	19,01

	A	B	C	D	E	F	G	H
D/KŁZ Ø104/110x55	100	110	55	113	58	74	103	155
D/KŁZ Ø125/220x55	124	220	55	224	58	30	85	230

## D/KO

KOLANO OKRĄGŁE

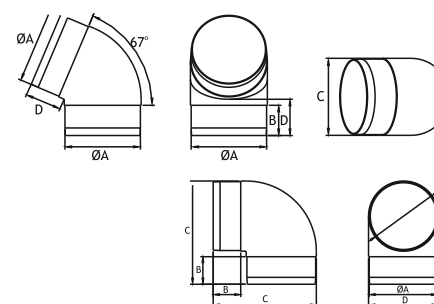

TYPE	INDEKS	KOLOR	OPAKOWANIE ZBIORCZE	WAGA	CENA
jednostka			[szt.]	[kg]	[PLN]
D/KO Ø100/67°	007-0217	biały	20	0,112	11,24
D/KO Ø100/90°	007-0216	biały	20	0,144	11,24
D/KO Ø125/67°	007-4344	biały	10	0,20	12,25
D/KO Ø125/90°	007-4345	biały	10	0,255	12,25

	A	B	C	D
D/KO Ø100/67°	100	32	102	39
D/KO Ø125/67°	125	40	127	44

	A	B	C	D
D/KO Ø100/90°	100	40	150	102
D/KO Ø125/90°	124	40	170	127

TYP	INDEKS	KOLOR	OPAKOWANIE ZBIORCZE	WAGA	CENA
jednostka			[szt.]	[kg]	[PLN]
D/UZP Ø104/110x55	007-0233	biały	20	0,084	9,01

	A	B	C	D	E	F	G	H	J	K
D/UZP	100	110	55	114	58	133	150	24	2	50

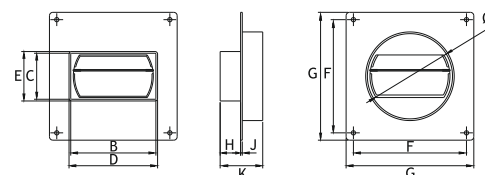

**D/UZP**  
KOŁNIERZ PRZYŚCIENNY  
Z PRZEPUSTNICĄ

TYP	INDEKS	KOLOR	OPAKOWANIE ZBIORCZE	WAGA	CENA
jednostka			[szt.]	[kg]	[PLN]
D/UKO Ø100	007-0235	biały	50	0,04	3,26
D/UKO Ø104	007-0240	biały	50	0,046	3,49

	A	B	C	D
D/UKO Ø100	100	140	152	2
D/UKO Ø104	104	140	152	2

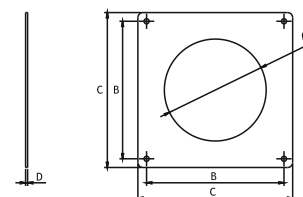

**D/UKO**  
KOŁNIERZ PRZYŚCIENNY

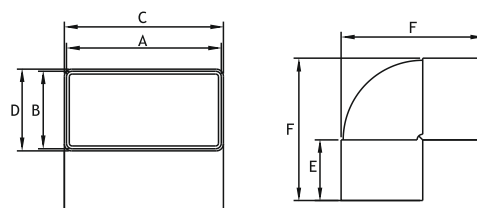
**D/KPI**  
 KOLANO PIONOWE  
 PŁASKIE

TYP	INDEKS	KOLOR	OPAKOWANIE ZBIORCZE	WAGA	CENA
jednostka			[szt.]	[kg]	[PLN]
D/KPI 110x55	007-0222	biały	20	0,092	6,19
D/KPI 220x55	007-1478	biały	20	0,14	25,30

	A	B	C	D	E	F
D/KPI 110x55	110	55	113	58	45	101
D/KPI 220x55	219	54	223	58	35	92

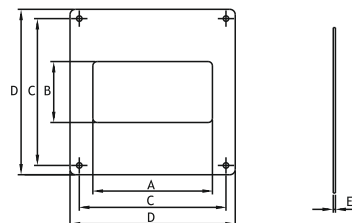
**D/UKP**  
 KOLNIERZ PRZYŚCIENNY

TYP	INDEKS	KOLOR	OPAKOWANIE ZBIORCZE	WAGA	CENA
jednostka			[szt.]	[kg]	[PLN]
D/UKP 110x55	007-0236	biały	20	0,044	3,94

	A	B	C	D	E
D/UKP 110x55	110	56	140	152	2



TYP	INDEKS	KOLOR	OPAKOWANIE ZBIORCZE	WAGA	CENA
jednostka			[szt.]	[kg]	[PLN]
D/UMO Ø100	007-0237	biały	20	0,03	3,94
D/UMO Ø104	007-0239	biały	20	0,04	4,17
D/UMO Ø125	007-4346	biały	20	0,005	4,81

	A	B	C	D	E
D/UMO Ø100	100	105	107	18	55
D/UMO Ø104	104	111	113	18	45
D/UMO Ø125	125	132	131	17	62

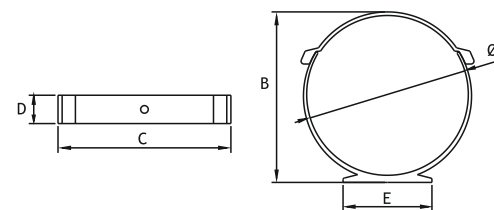

**D/UMO**  
UCHWYT MOCUJĄCY  
OKRĄGŁY

TYP	INDEKS	KOLOR	OPAKOWANIE ZBIORCZE	WAGA	CENA
jednostka			[szt.]	[kg]	[PLN]
D/UMP 110x55	007-0238	biały	20	0,022	2,78
D/UMP 220x55	007-1489	biały	20	0,116	5,80

	A	B	C	D	E	F
D/UMP 110x55	111	55	116	60	78	20
D/UMP 220x55	219	54	224	56	129	26

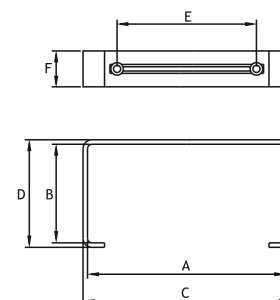

**D/UMP**  
UCHWYT MOCUJĄCY  
PŁASKI

## D/UOP

KOŁNIERZ PRZYŚCIENNY Z PRZEPUSTNICĄ

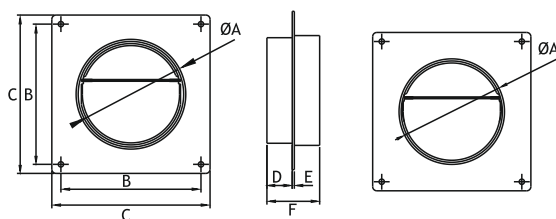

TYP	INDEKS	KOLOR	OPAKOWANIE ZBIORCZE	WAGA	CENA
jednostka			[szt.]	[kg]	[PLN]
D/UOP Ø100/104	007-0230	biały	20	0,074	7,12
D/UOP Ø125/104	007-4347	biały	20	0,117	8,96

	A	B	C	D	E	F	G
D/UOP Ø100/104	100	133	150	24	2	50	104
D/UOP Ø125/104	125	133	150	24	2	79	125

## D/TP

TRÓJNIK PŁASKI

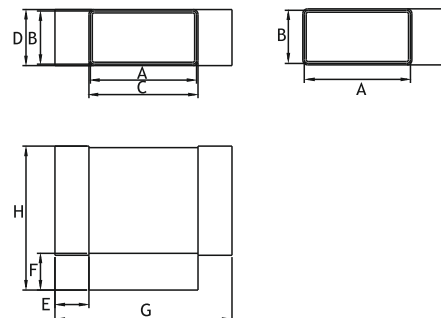

TYP	INDEKS	KOLOR	OPAKOWANIE ZBIORCZE	WAGA	CENA
jednostka			[szt.]	[kg]	[PLN]
D/TP 110x55	007-0227	biały	20	0,134	10,95
D/TP 220x55	007-0277	biały	20	0,41	26,24

	A	B	C	D	E	F	G	H
D/TP 110x55	110	55	113	58	36	38	184	150
D/TP 220x55	220	55	223	58	44	45	308	265

TYP	INDEKS	KOLOR	OPAKOWANIE ZBIORCZE	WAGA	CENA
jednostka			[szt.]	[kg]	[PLN]
D/ZK Ø100/110x55	007-0219	biały	20	0,048	7,12

	A	B	C	D	E	F	G	H	J
D/ZK Ø100/110x55	100	110	55	114	58	30	2	64	105

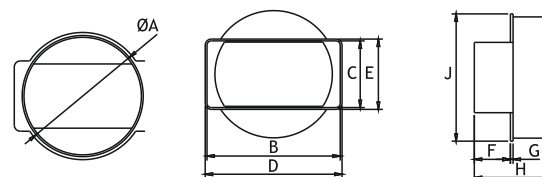

**D/ZK**  
ŁĄCZNIK PRZEKROJÓW  
ZMIENNYCH-KRÓTKI

TYP	INDEKS	KOLOR	OPAKOWANIE ZBIORCZE	WAGA	CENA
jednostka			[szt.]	[kg]	[PLN]
D/RE 100/125	007-0307	biały	20	0,05	8,59
D/RE 125/150	007-0308	biały	20	0,052	10,00

	A	B	C	D	E
D/RE 100/125	100	125	104	24	85
D/RE 125/150	122	150	125	24	85

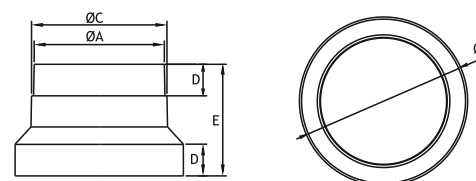

**D/RE**  
REDUKCJA

## D/REW

REDUKCJA  
WIELOSTOPNIOWA

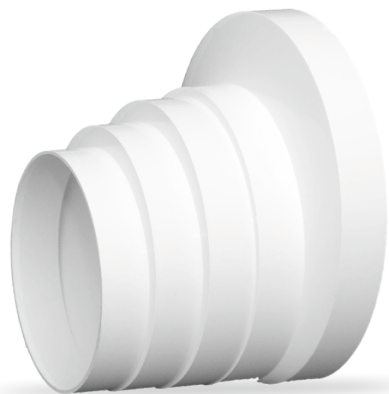

TYP	INDEKS	KOLOR	OPAKOWANIE ZBIORCZE	WAGA	CENA
jednostka			[szt.]	[kg]	[EUR]
D/REW	007-1828	biały	20	0,082	9,96

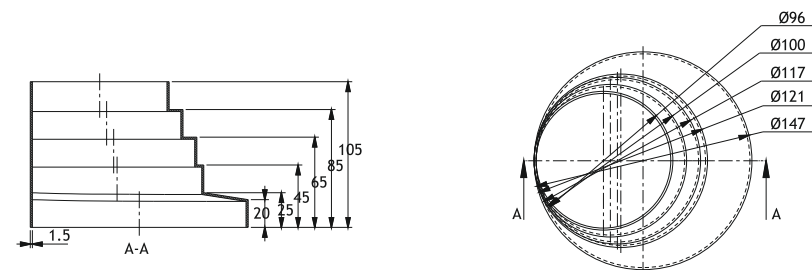

## D/ZD

ŁĄCZNIK PRZEKROJÓW  
ZMIENNYCH - DŁUGI

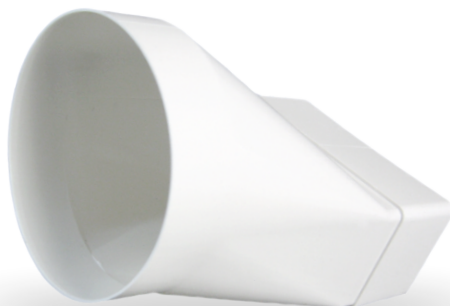

TYP	INDEKS	KOLOR	OPAKOWANIE ZBIORCZE	WAGA	CENA
jednostka			[szt.]	[kg]	[EUR]
D/ZD Ø104/110x55	007-0224	biały	10	0,13	7,92
D/ZD Ø125/220x55	007-1480	biały	10	0,228	17,49

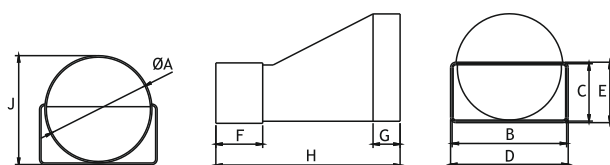

	A	B	C	D	E	F	G	H	J
D/ZD Ø104/110x55	100	110	54	113	58	45	26	117	105
D/ZD Ø125/220x55	127	219	53	223	57	32	30	118	130

TYP	INDEKS	KOLOR	OPAKOWANIE ZBIORCZE	WAGA	CENA
jednostka			[szt.]	[kg]	[PLN]
D/PW 110x55	007-0226	biały	20	0,106	8,71

	A	B	C	D	E	F
D/PW 110x55	110	55	114	57	45	54

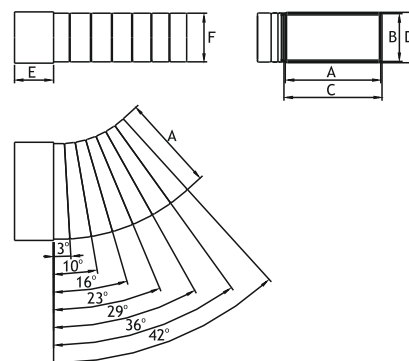

**D/PW**  
KOLANO POZIOME  
WIELOKATNE



TYP	INDEKS	KOLOR	OPAKOWANIE ZBIORCZE	WAGA	CENA
jednostka			[szt.]	[kg]	[PLN]
D/KPO 110x55	007-0225	biały	20	0,104	7,44
D/KPO 220x55	007-1479	biały	20	0,294	25,64

	A	B	C	D	E	F
D/KPO 110x55	110	55	114	58	45	157
D/KPO 220x55	219	54	223	58	35	225

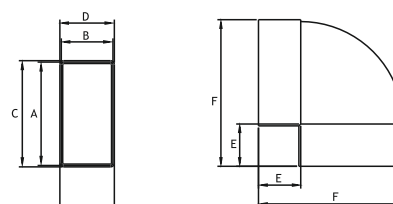

**D/KPO**  
KOLANO POZIOME  
PŁASKIE



## D/ŁO

ŁĄCZNIK KANAŁÓW  
OKRĄGLYCH

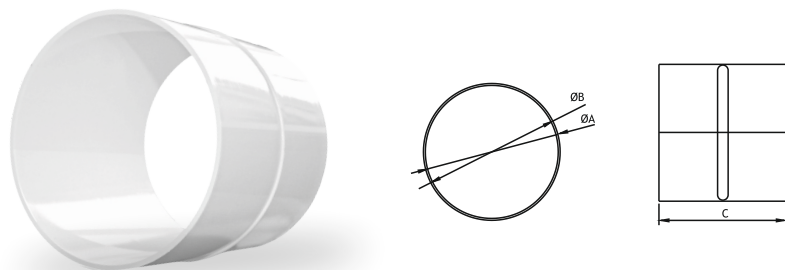

TYP	INDEKS	KOLOR	OPAKOWANIE ZBIORCZE	WAGA	CENA
jednostka			[szt.]	[kg]	[PLN]
D/ŁO Ø100	007-0221	biały	20	0,066	3,67
D/ŁO Ø104	007-0333	biały	20	0,068	5,73
D/ŁO Ø125	007-4374	biały	20	0,102	4,62

	A	B	C
D/ŁO Ø100	100	96	98
D/ŁO Ø104	103	100	98
D/ŁO Ø125	130	127	100

## D/ŁOP

ŁĄCZNIK KANAŁÓW  
OKRĄGLYCH  
Z PRZEPUSTNICĄ

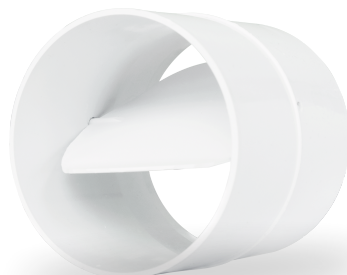

TYP	INDEKS	KOLOR	OPAKOWANIE ZBIORCZE	WAGA	CENA
jednostka			[szt.]	[kg]	[PLN]
D/ŁOP Ø100	007-4363	biały	20	0,075	4,85

	A	B	C
D/ŁOP Ø100	100	96	98

## D/TO

TRÓJNIK OKRĄGŁY

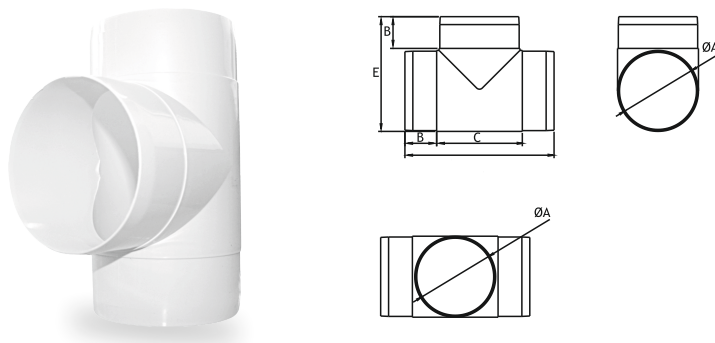

TYP	INDEKS	KOLOR	OPAKOWANIE ZBIORCZE	WAGA	CENA
jednostka			[szt.]	[kg]	[PLN]
D/TO Ø100	007-0218	biały	10	0,188	14,11
D/TO Ø125	007-4343	biały	10	0,32	15,06

	A	B	C	D	E
D/TO Ø100	100	40	108	188	145
D/TO Ø125	125	40	133	213	169



TYP	INDEKS	KOLOR	OPAKOWANIE ZBIORCZE	WAGA	CENA
jednostka			[szt.]	[kg]	[PLN]
D/O Ø100 0,50 mb	007-0207	biały	30	0,336	7,47
D/O Ø100 1,00 mb	007-0208	biały	15	0,74	14,42
D/O Ø100 1,50 mb	007-0209	biały	15	1,10	20,60
D/O Ø104 0,50 mb	007-0210	biały	30	0,41	7,47
D/O Ø104 1,00 mb	007-0211	biały	15	0,72	14,42
D/O Ø104 1,50 mb	007-0212	biały	15	1,168	20,60
D/O Ø125 0,50 mb	007-4340	biały	10	0,538	9,63
D/O Ø125 1,00 mb	007-4341	biały	10	0,986	17,45
D/O Ø125 1,50 mb	007-4342	biały	10	1,454	27,08
D/O Ø150 0,50 mb*	007-1710	biały	12	0,82	17,86
D/O Ø150 1,00 mb*	007-1711	biały	6	1,71	32,45
D/O Ø150 1,50 mb*	007-1712	biały	6	2,35	46,37

	A	B
D/O Ø100 0,5	100	500
D/O Ø100 1,0	100	1000
D/O Ø100 1,5	100	1500
D/O Ø104 0,5	104	500
D/O Ø104 1,0	104	1000
D/O Ø104 1,5	104	1500
D/O Ø125 0,5	125	500
D/O Ø125 1,0	125	1000
D/O Ø125 1,5	150	1500
D/O Ø150 0,5	150	500
D/O Ø150 1,0	150	1000
D/O Ø150 1,5	150	1500

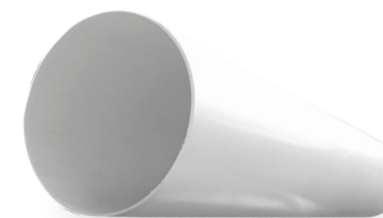

**D/O**  
KANAL OKRĄGLY

Istnieje możliwość zamówienia wersji pakowanej. W wersji pakowanej cena wzrasta o 8% ceny katalogowej.

\* Produkt dostępny jest jedynie przy minimalnym zamówieniu 300 sztuk

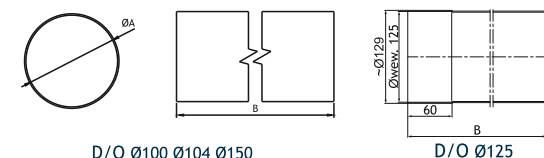

Kanale D/O Ø125 wyposażone są w mufę na jednym z końców

TYP	INDEKS	KOLOR	OPAKOWANIE ZBIORCZE	WAGA	CENA
jednostka			[szt.]	[kg]	[PLN]
D/P 110x55/ 0,50 mb	007-0213	biały	48	0,316	8,55
D/P 110x55/ 1,00 mb	007-0214	biały	24	0,614	15,04
D/P 110x55/ 1,50 mb	007-0215	biały	24	0,95	19,72
D/P 220x55/ 0,50 mb	007-1507	biały	20	0,656	12,60
D/P 220x55/ 1,00 mb	007-1508	biały	10	1,452	21,67
D/P 220x55/ 1,50 mb	007-1509	biały	10	1,938	31,98

	A	B	C	D	E
D/P 110x55/ 0,5	106	51	110	55	500
D/P 110x55/ 1,0	106	51	110	55	1000
D/P 110x55/ 1,5	106	51	110	55	1500
D/P 220x55/ 0,5	215	50	219	54	500
D/P 220x55/ 1,0	215	50	219	54	1000
D/P 220x55/ 1,5	215	50	219	54	1500

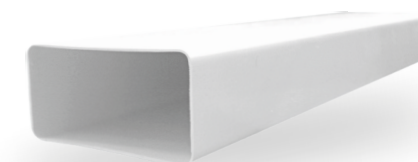
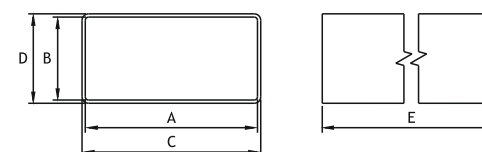

Istnieje możliwość zamówienia wersji pakowanej. W wersji pakowanej cena wzrasta o 8% ceny katalogowej.

**D/P**  
KANAL PŁASKI



**TERMOFLEKS**  
 PRZEWÓD WENTYLACYJNY  
 Z IZOLACJĄ TERMICZNĄ

TYP	INDEKS	KOLOR	OPAKOWANIE ZBIORCZE	WAGA	CENA
jednostka			[szt.]	[kg]	[PLN]
TERMOFLEKS Ø100/ 5mb 150°C	007-1571	srebrny	1	2,262	53,14
TERMOFLEKS Ø100/ 10mb 150°C	007-1577	srebrny	1	3,15	105,93
TERMOFLEKS Ø125/ 5mb 150°C	007-1572	srebrny	1	2,38	58,80
TERMOFLEKS Ø125/ 10mb 150°C	007-1578	srebrny	1	3,99	117,59
TERMOFLEKS Ø150/ 5mb 150°C	007-1573	srebrny	1	2,546	67,16
TERMOFLEKS Ø150/ 10mb 150°C	007-1579	srebrny	1	4,478	134,21
TERMOFLEKS Ø160/ 5mb 150°C	007-1574	srebrny	1	3,04	72,82
TERMOFLEKS Ø160/ 10mb 150°C	007-1580	srebrny	1	4,66	146,00
TERMOFLEKS Ø200/ 5mb 150°C	007-1575	srebrny	1	2,636	89,43
TERMOFLEKS Ø200/ 10mb 150°C	007-1581	srebrny	1	5,68	178,87
TERMOFLEKS Ø250/ 5mb 150°C	007-1576	srebrny	1	4,64	105,93
TERMOFLEKS Ø250/ 10mb 150°C	007-1582	srebrny	1	7,982	211,98

TYP	INDEKS	KOLOR	OPAKOWANIE ZBIORCZE	WAGA	CENA
jednostka			[szt.]	[kg]	[PLN]
TERMOFLEKS Ø100/ 5mb 250°C	007-1583	srebrny	1	2,262	61,04
TERMOFLEKS Ø100/ 10mb 250°C	007-1589	srebrny	1	3,15	107,12
TERMOFLEKS Ø125/ 5mb 250°C	007-1584	srebrny	1	2,382	64,69
TERMOFLEKS Ø125/ 10mb 250°C	007-1590	srebrny	1	4,324	129,38
TERMOFLEKS Ø150/ 5mb 250°C	007-1585	srebrny	1	2,546	76,36
TERMOFLEKS Ø150/ 10mb 250°C	007-1591	srebrny	1	4,58	153,07
TERMOFLEKS Ø160/ 5mb 250°C	007-1586	srebrny	1	3,04	78,38
TERMOFLEKS Ø160/ 10mb 250°C	007-1592	srebrny	1	4,80	156,83
TERMOFLEKS Ø200/ 5mb 250°C	007-1587	srebrny	1	2,636	95,21
TERMOFLEKS Ø200/ 10mb 250°C	007-1593	srebrny	1	5,68	190,41
TERMOFLEKS Ø250/ 5mb 250°C	007-1588	srebrny	1	4,64	123,60
TERMOFLEKS Ø250/ 10mb 250°C	007-1594	srebrny	1	9,28	247,33

TYP	INDEKS	KOLOR	OPAKOWANIE ZBIORCZE	WAGA	CENA
jednostka			[szt.]	[kg]	[PLN]
AKUSTIFLEKS Ø100/ 1 mb	012-0326	srebrny	1	0,796	81,85
AKUSTIFLEKS Ø125/ 1 mb	012-0327	srebrny	1	0,906	89,07
AKUSTIFLEKS Ø150/ 1 mb	012-0328	srebrny	1	1,202	91,22
AKUSTIFLEKS Ø160/ 1 mb	012-0329	srebrny	1	1,09	105,92
AKUSTIFLEKS Ø200/ 1 mb	012-0330	srebrny	1	1,674	132,41
AKUSTIFLEKS Ø250/ 1 mb	012-0331	srebrny	1	2,40	238,33



**AKUSTIFLEKS**  
PRZEWÓD WENTYLACYJNY  
Z IZOLACJĄ AKUSTYCZNĄ



TYP	INDEKS	KOLOR	OPAKOWANIE ZBIORCZE	WAGA	CENA
jednostka			[szt.]	[kg]	[PLN]
FLEKS Ø100/ 5 mb	012-0632	srebrny	1	0,444	17,68
FLEKS Ø100/ 10 mb	012-0601	srebrny	1	0,888	30,92
FLEKS Ø125/ 5 mb	012-0633	srebrny	1	0,512	22,08
FLEKS Ø125/ 10 mb	012-0602	srebrny	1	1,01	35,34
FLEKS Ø150/ 5 mb	012-0634	srebrny	1	0,582	24,29
FLEKS Ø150/ 10 mb	012-0603	srebrny	1	1,16	44,17
FLEKS Ø160/ 5 mb	012-0635	srebrny	1	0,618	26,51
FLEKS Ø160/ 10 mb	012-0604	srebrny	1	1,27	48,59
FLEKS Ø200/ 5 mb	012-0636	srebrny	1	0,742	28,71
FLEKS Ø200/ 10 mb	012-0605	srebrny	1	1,594	55,21
FLEKS Ø250/ 5 mb	012-0637	srebrny	1	1,232	35,34
FLEKS Ø250/ 10 mb	012-0606	srebrny	1	2,464	70,67
FLEKS Ø315/ 5 mb	012-0638	srebrny	1	1,765	46,37
FLEKS Ø315/ 10 mb	012-0627	srebrny	1	3,512	92,76

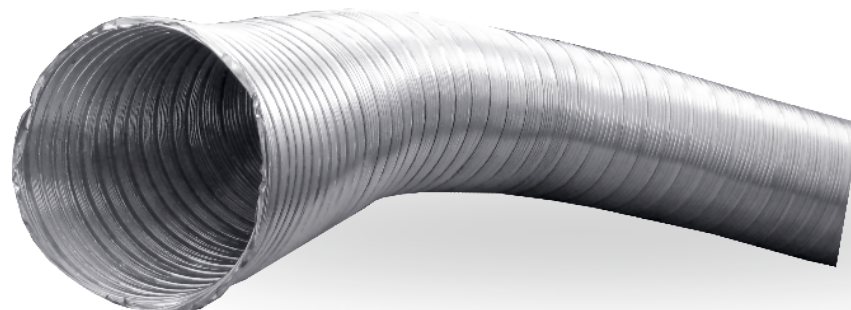

**FLEKS**  
PRZEWÓD  
WENTYLACYJNY

**ALUFLEKS**  
 PRZEWÓD WENTYLACYJNY

TYP	INDEKS	OPAKOWANIE ZBIORCZE	WAGA	CENA/szt.	CENA/szt.*
jednostka		[szt.]	[kg]	[PLN]	[PLN]
ALUFLEKS Ø080/ 3mb	007-0413	120	0,37	21,24	12,01
ALUFLEKS Ø100/ 3mb	007-0128	80	0,46	22,25	14,54
ALUFLEKS Ø110/ 3mb	007-0129	67	0,48	26,30	17,39
ALUFLEKS Ø115/ 3mb	007-1675	63	0,505	24,38	17,88
ALUFLEKS Ø120/ 3mb	007-0130	60	0,53	27,31	18,62
ALUFLEKS Ø125/ 3mb	007-0131	50	0,55	28,31	17,37
ALUFLEKS Ø130/ 3mb	007-0132	48	0,60	30,16	19,34
ALUFLEKS Ø140/ 3mb	007-0414	43	0,64	33,98	21,87
ALUFLEKS Ø150/ 3mb	007-0133	35	0,66	38,23	21,41
ALUFLEKS Ø160/ 3mb	007-0134	34	0,70	48,96	23,12
ALUFLEKS Ø200/ 3mb	007-0135	20	0,86	57,34	40,85
ALUFLEKS Ø250/ 3mb	007-0415	12	1,15	61,59	43,26
ALUFLEKS Ø315/ 3mb	007-0416	7	1,20	80,70	60,07

\*PROMOCJA: kontakt z Przedstawicielem Handlowym